

MORE INFORMATION - MÁS INFORMACIÓN

Visit our website for more information of this series and to download the documentation in pdf format.

Visite nuestra página web para una mayor información de esta serie y poder descargar la documentación en formato pdf.



www.gruposopena.com



Sections

Secciones

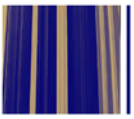

Sections - *Secciones*

- DETALLE MONTAJE LAMA FIJA CON SOPORTES -

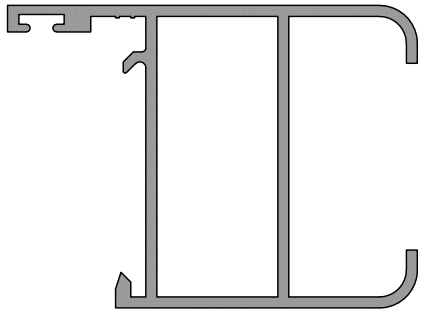

201611

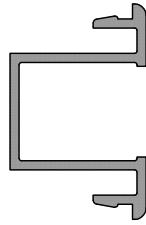

350421

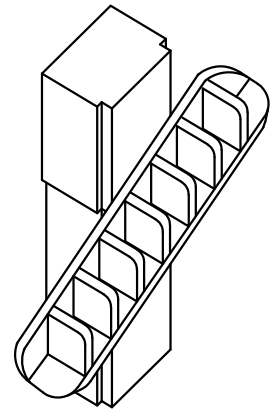

20.04.01

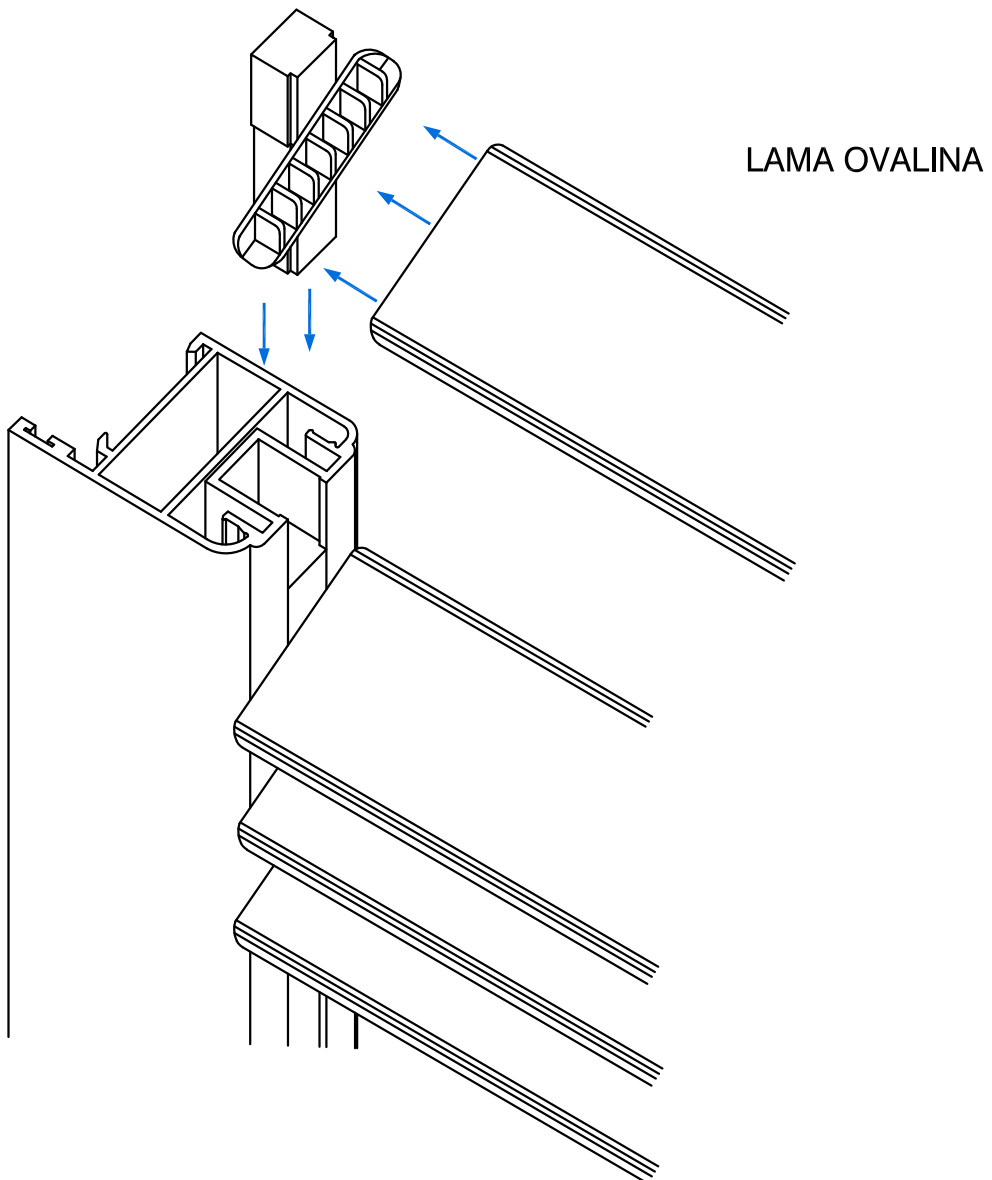

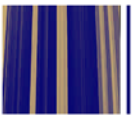

Sections - *Secciones*

- DETALLE MONTAJE LAMA FIJA CON 02002 -

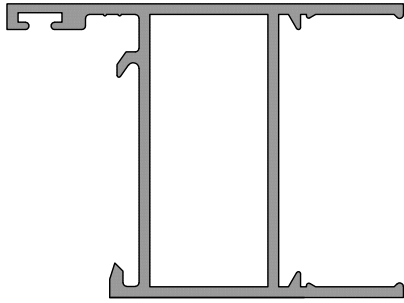

201610

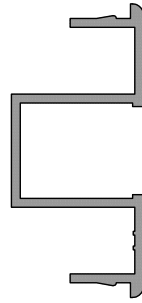

200421

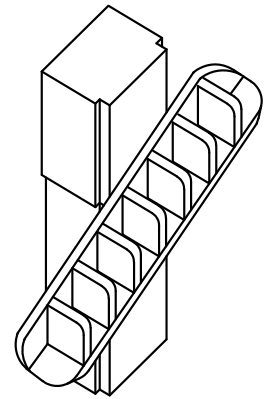

20.04.01

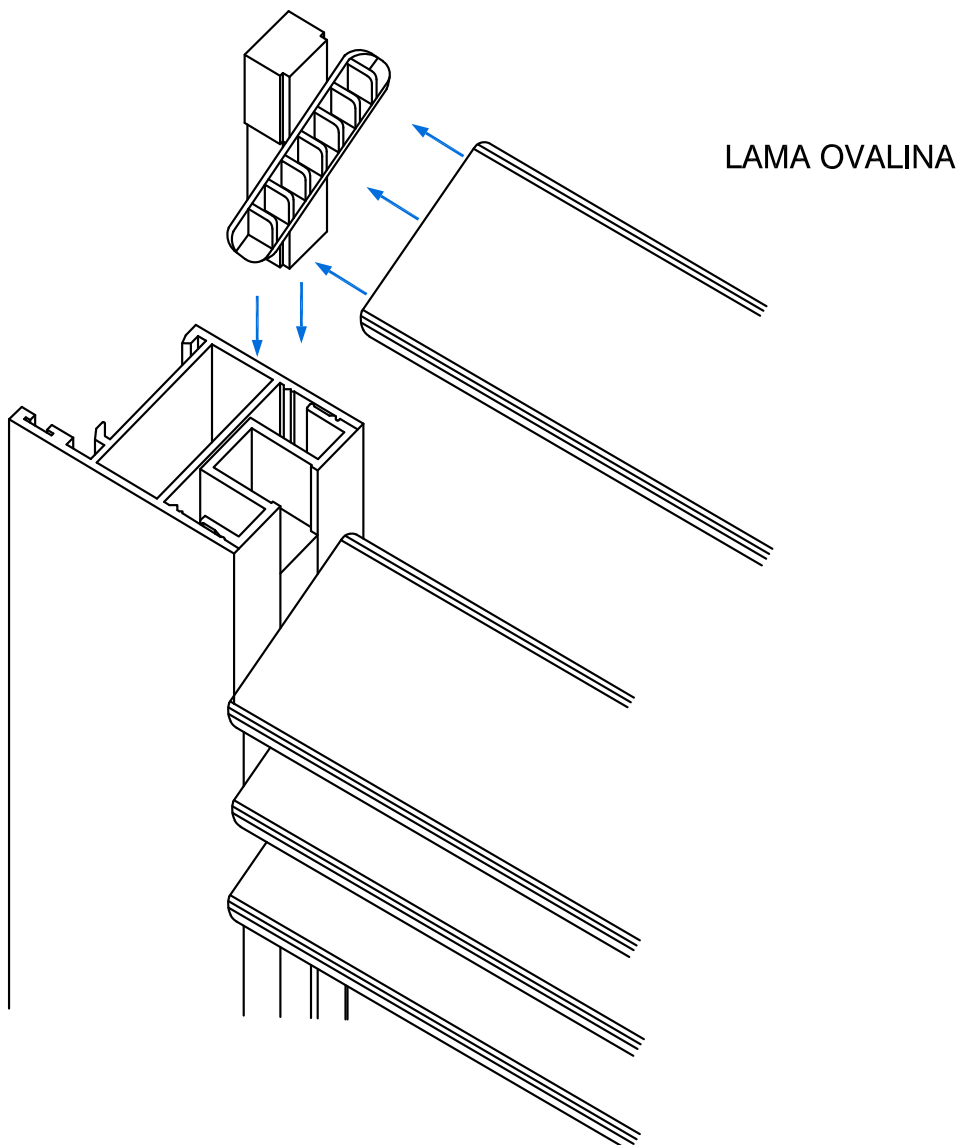

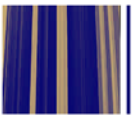

Sections - *Secciones*

- DETALLE MONTAJE LAMA FIJA CON SOPORTES -

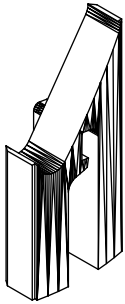

20.04.03

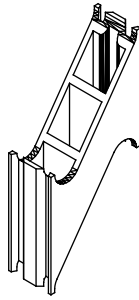

20.04.02

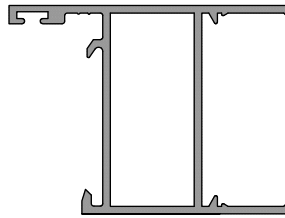

201610



205240

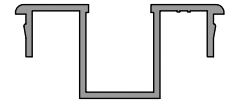

200421

