

MORE INFORMATION - MÁS INFORMACIÓN

Visit our website for more information of this series and to download the documentation in pdf format.

Visite nuestra página web para una mayor información de esta serie y poder descargar la documentación en formato pdf.



www.gruposopena.com



Sections

Secciones

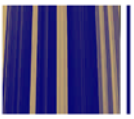

Sections - Secciones

- 6 (& , İ 1 * 8 , \$ 6 8 3 (5 ; 2 5

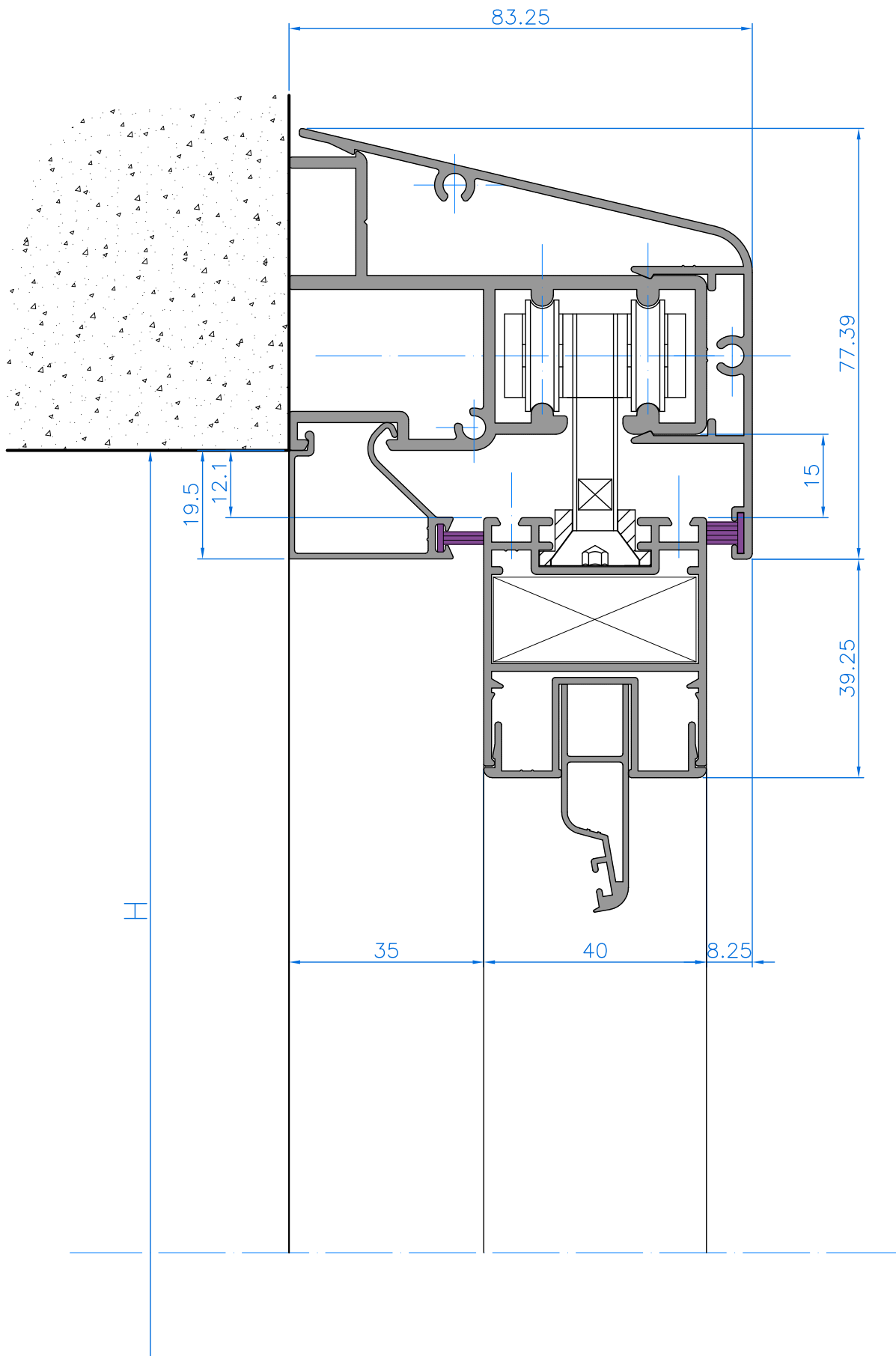

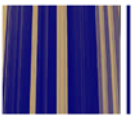

Sections - Secciones

- 6 (8, 1) (5, 25-

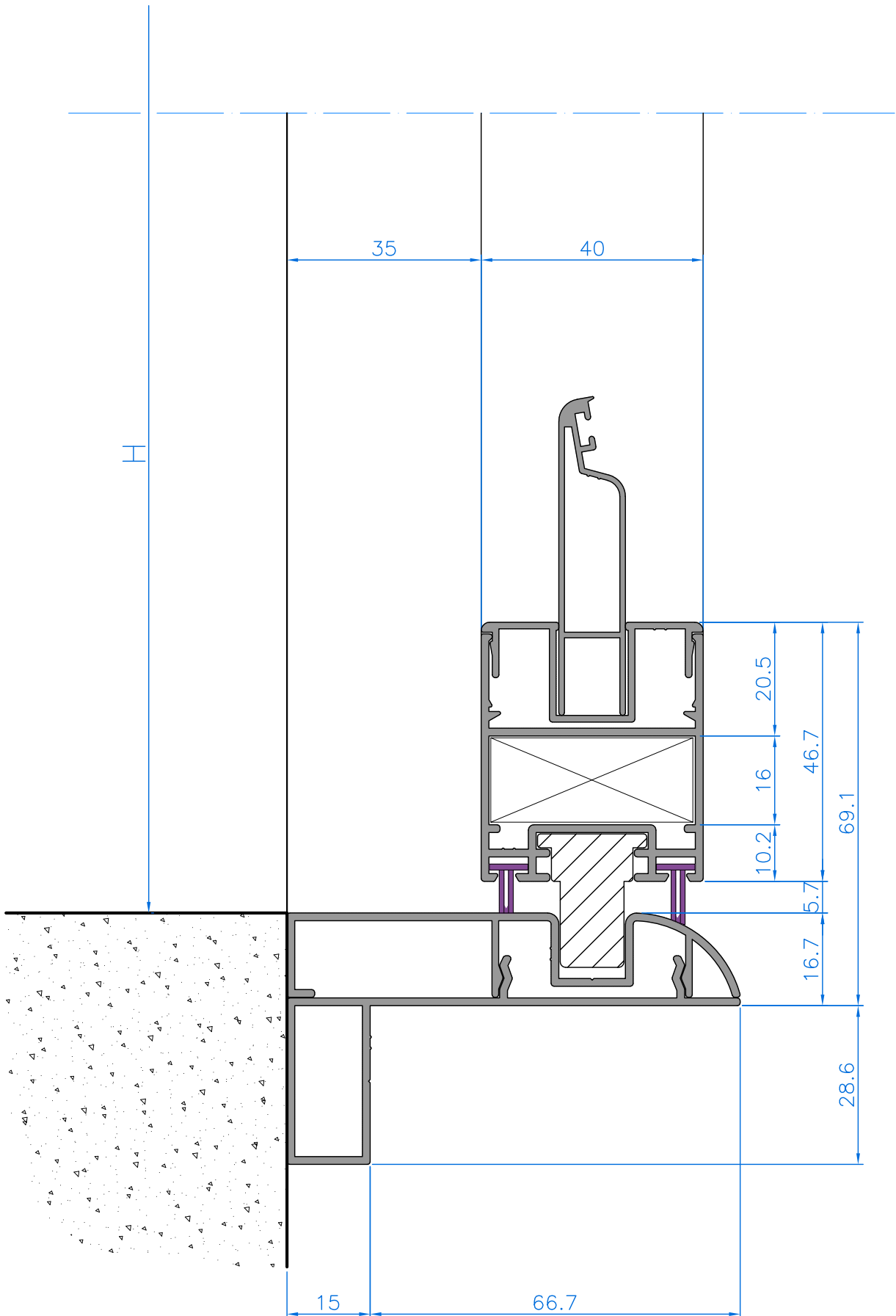

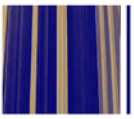

Sections - *Secciones*

SECCION NUDO CENTRAL

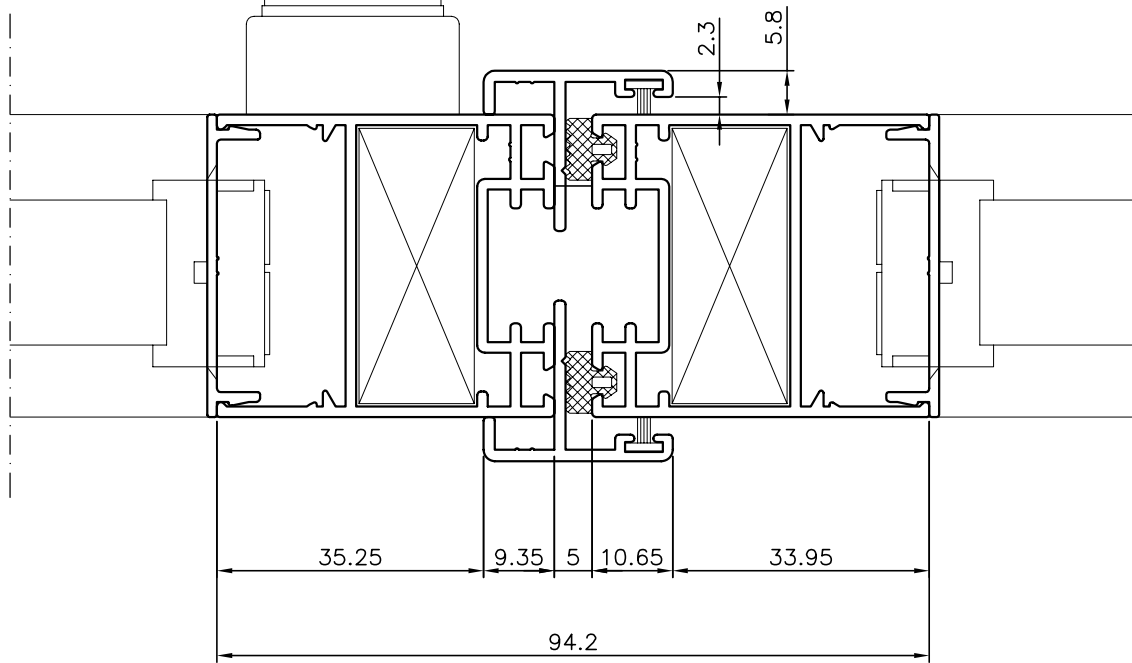



MONTAJE

DETALLE MONTAJE LAMA FIJA



20.04.01



| | |
|---|--------|
| A | 02037 |
| N | 205040 |

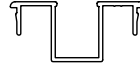

| | |
|---|--------|
| A | 02010 |
| N | 200421 |

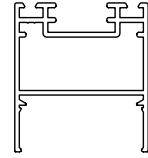

| | |
|---|--------|
| A | 02064 |
| N | 201622 |

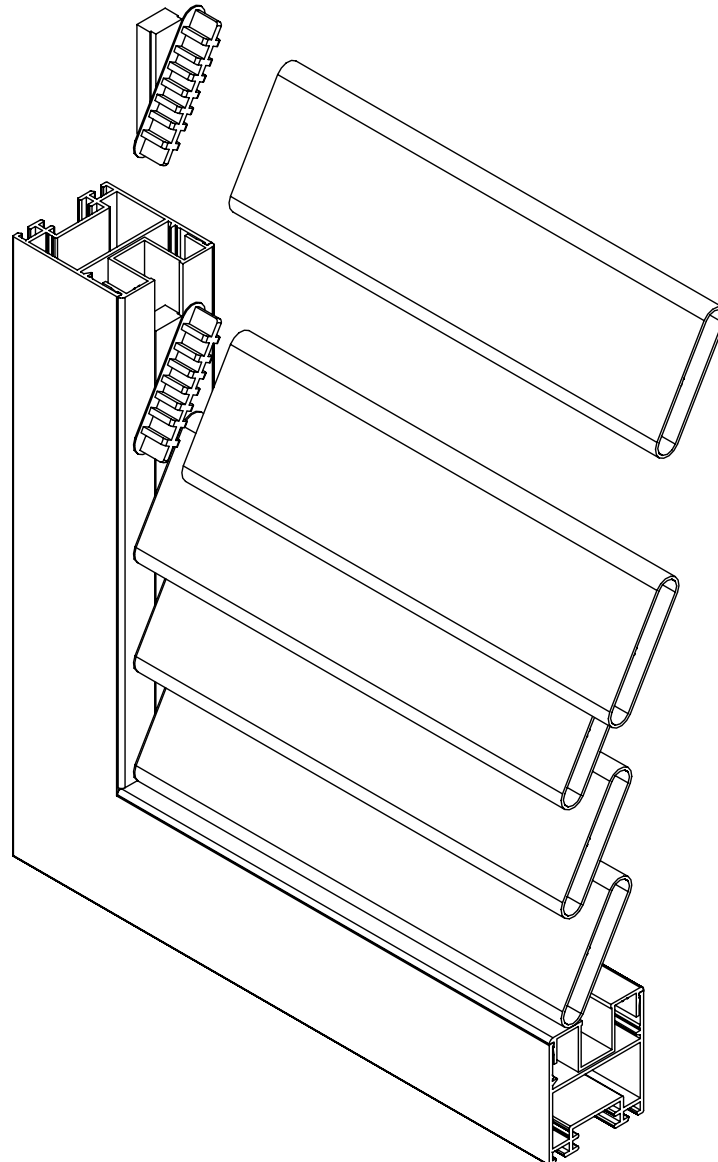

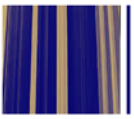

MONTAJE

DETALLE MONTAJE LAMA FIJA

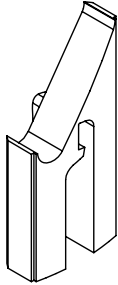

20.04.03

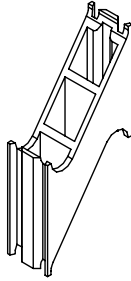

20.04.02

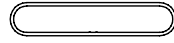

| | |
|---|--------|
| A | 02037 |
| N | 205040 |



| | |
|---|--------|
| A | 02010 |
| N | 200421 |



| | |
|---|--------|
| A | 02008 |
| N | 203540 |

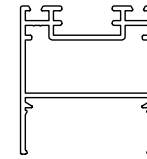

| | |
|---|--------|
| A | 02064 |
| N | 201622 |



| | |
|---|--------|
| A | 02009 |
| N | 205240 |

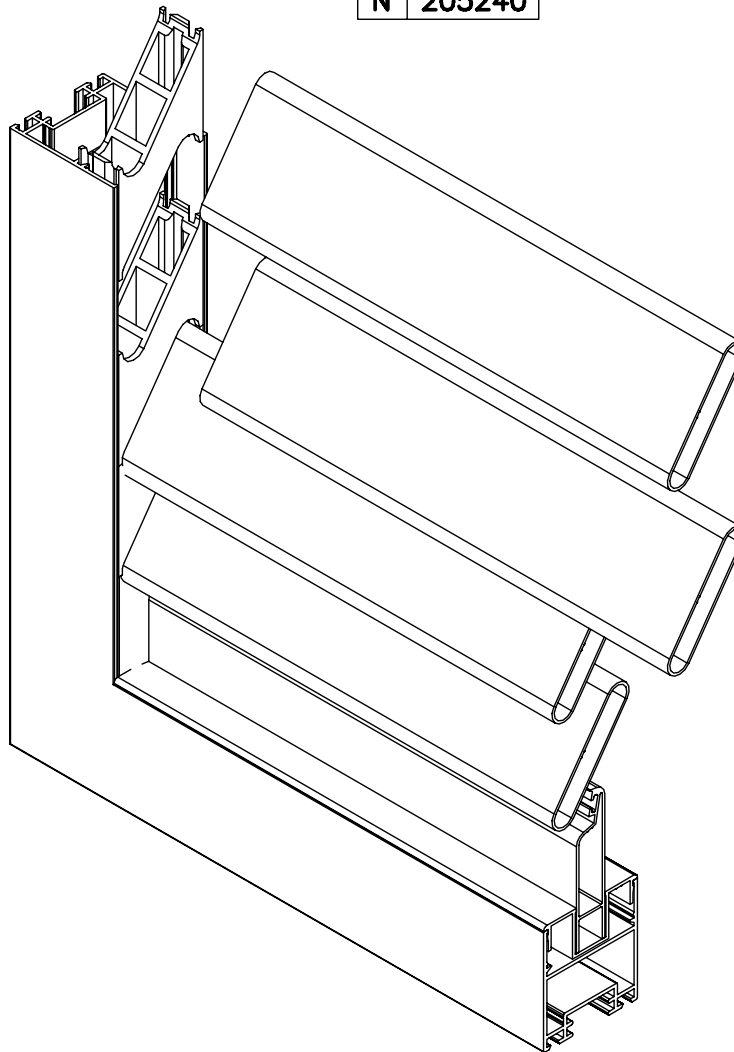

A: Ref. antigua