

MORE INFORMATION

Visit our web for more information about this Series and to be able to unload the documentation in format pdf.

www.gruposopena.com





Machining
Mecanizados
Cutting schemes
Esquemas de corte

Á

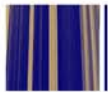

7i m]b['gV\Ya Yg - 7cfhY

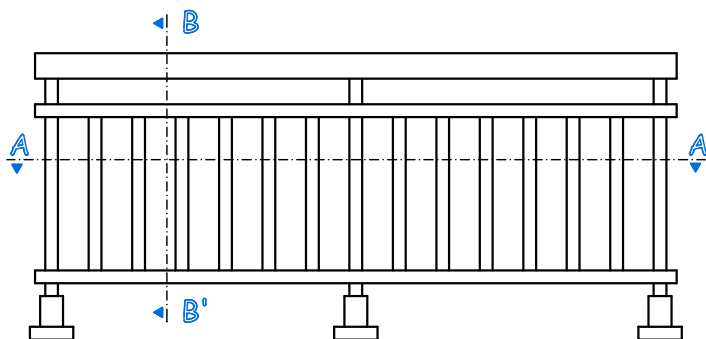
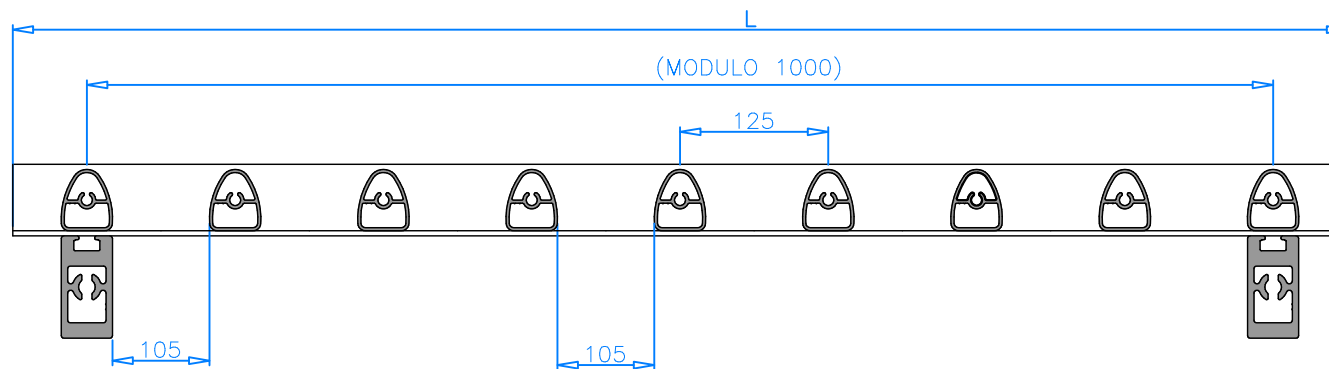
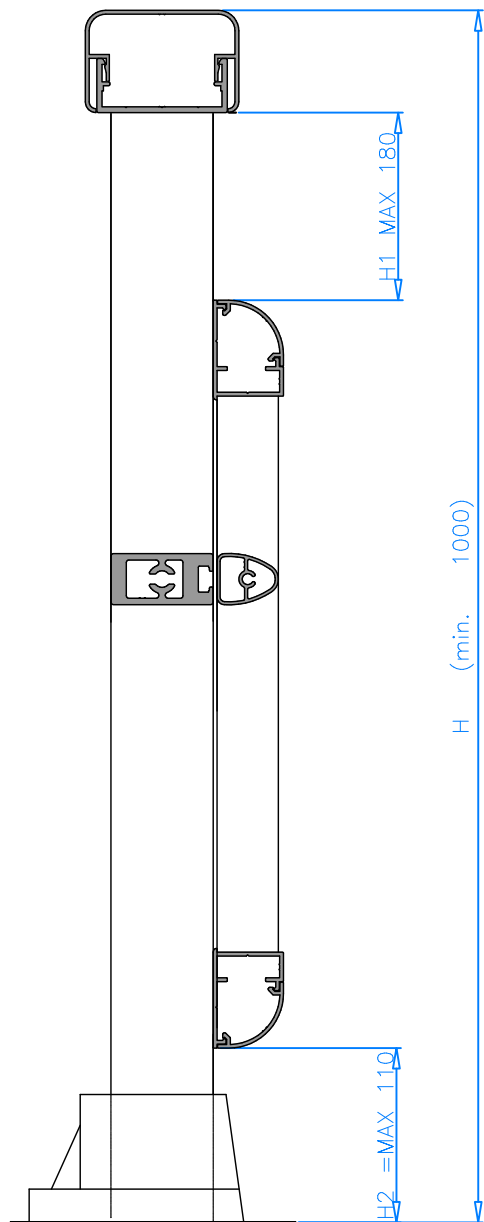







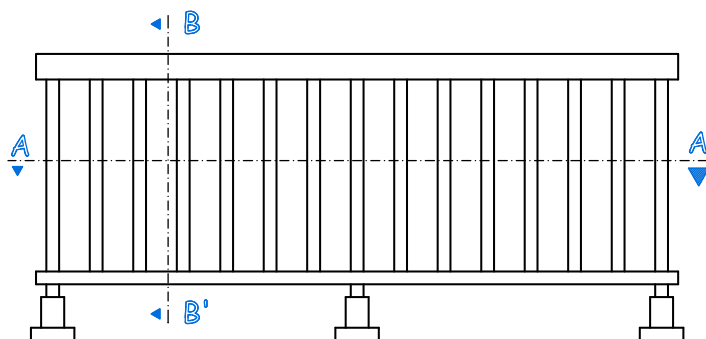
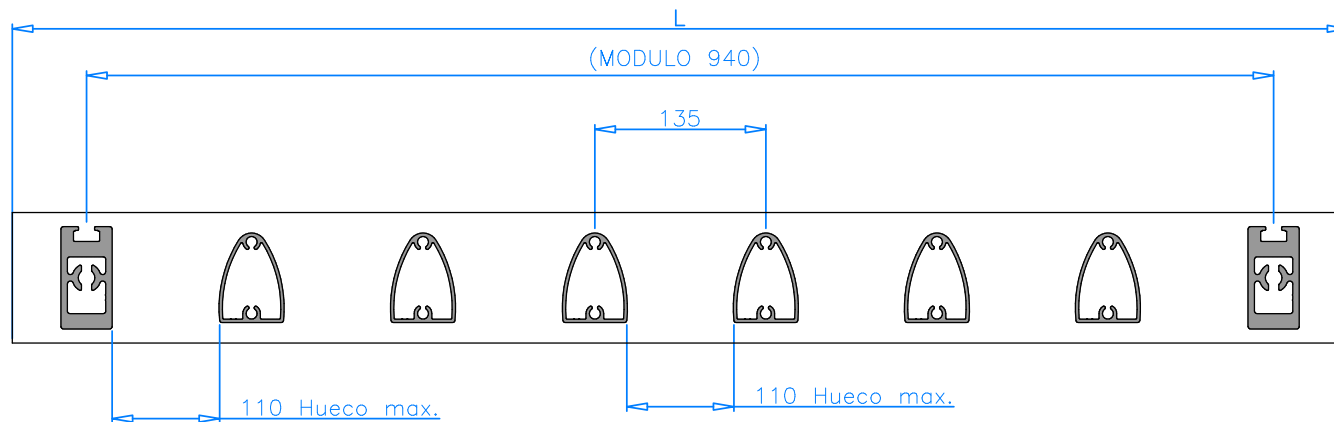
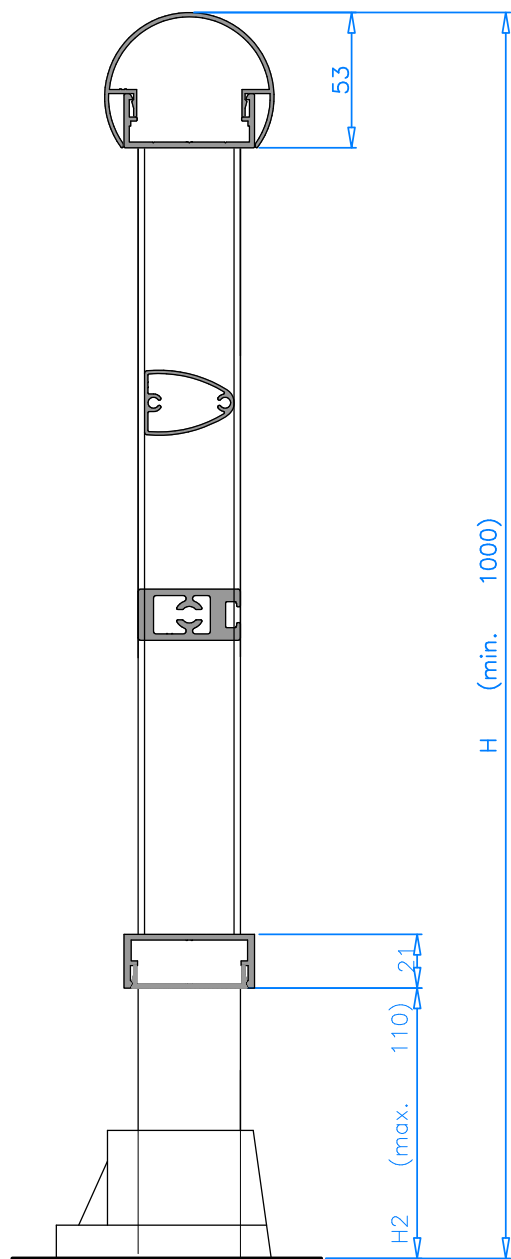







DESGLOSE DE MATERIALES

PERFIL	CODIGO	DENOMINACION	CORTE	Nº PIEZAS	MEDIDA
	50013	PASAMANOS		1	L
	50018	ANCLAJE PASAMANOS		1	L
	50050	PORTABARROTILLO		2	L
	50052	TAPA		2	L
	50030	PILAR		$\frac{L}{1000} + 1$	H-40
	50060	BARROTILLO		$\frac{8 \times L}{1000}$	H-H1-H2-100
	5070461	ANCLAJE PAVIMENTO		IGUAL Nº PILASTRAS	
	5079886	TAPA PORTABARROTILLOS DERECHA		Nº DE BARRAS 50050	
	5079887	TAPA PORTABARROTILLOS IZQUIERDA		Nº DE BARRAS 50050	
	5070382	TORNILLO, TUERCA Y ARANDELA M6 INOX		2 X (Nº PILAR)	
	5070450	TAPA PASAMANO		2	
	5070041	JUNTA RANURA PILAR		Nº PILAR	H-40
		TORNILLO INOXIDABLE		2 X (Nº 50060)	4.8x32
		TORNILLO INOXIDABLE		Nº PILAR	M8x30

7i m]b['gV\Ya Yg - 7cfhY



DESGLOSE DE MATERIALES

PERFIL	CODIGO	DENOMINACION	CORTE	N° PIEZAS	MEDIDA
	50015	PASAMANOS		1	L
	50020	TAPA		1	L
	50018	ANCLAJE PASAMANOS		2	L
	50061	BARROTE		$\frac{6 \times L}{940}$	H-H2-74
	50030	PILAR		$\frac{L}{940} + 1$	H-53
	5070461	ANCLAJE PAVIMENTO		IGUAL N°	PILASTRAS
	5070723	TAPA PASAMANO		2	
	5070041	JUNTA RANURA PILAR		N° PILAR	H-53
		TORNILLO INOXIDABLE		4 X (N° 50061)	4.8x32
		TORNILLO INOXIDABLE		N° PILAR	M8x30

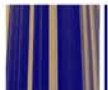

7i m]b['gV\Ya Yg - 7cfhY

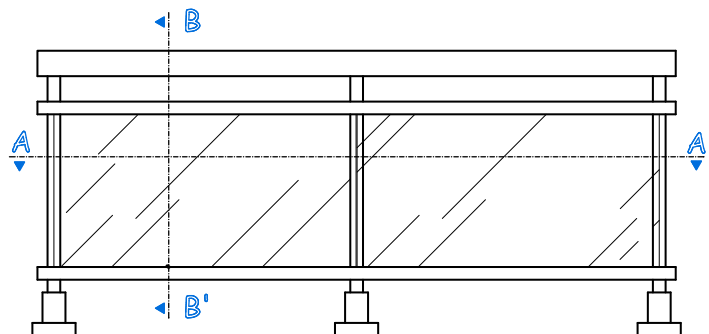
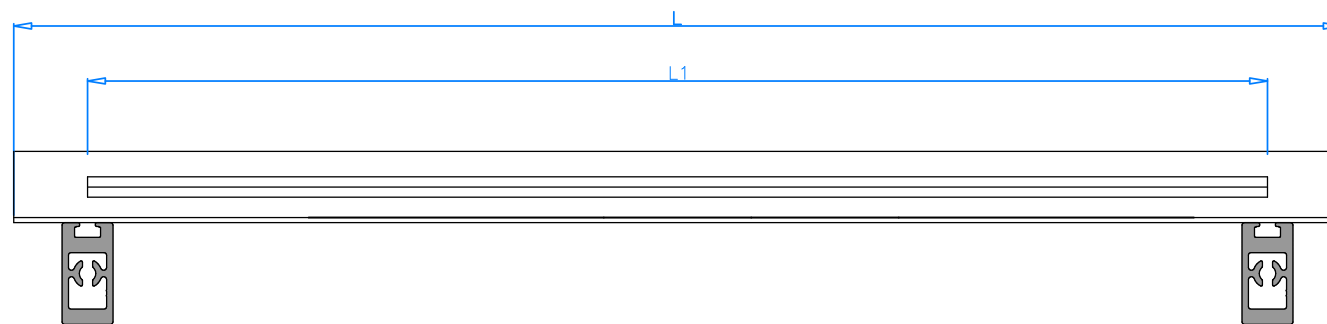
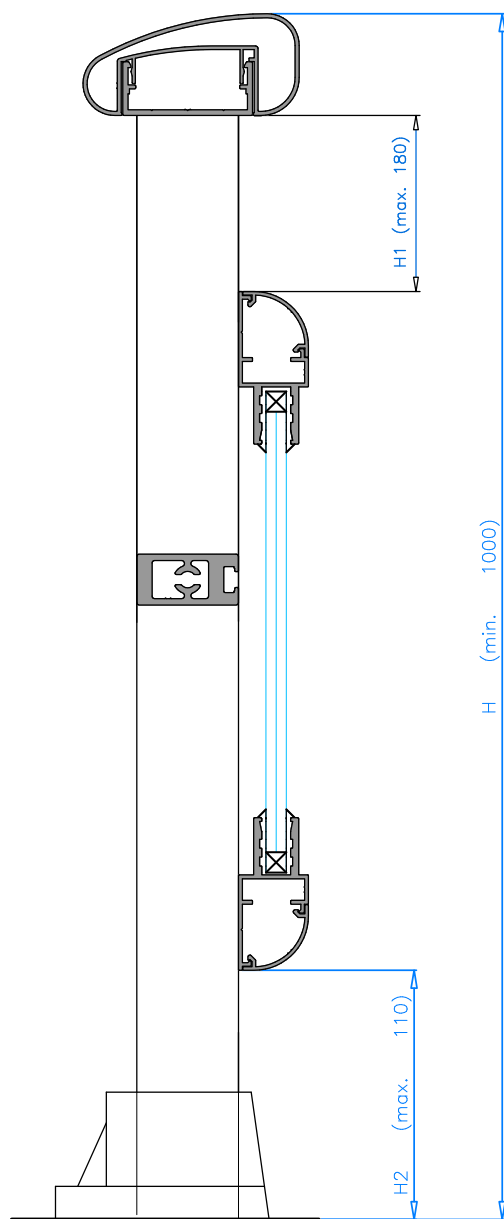

DESGLOSE DE MATERIALES

PERFIL	CODIGO	DENOMINACION	CORTE	N° PIEZAS	MEDIDA
	50016	PASAMANOS		1	L
	50018	ANCLAJE PASAMANOS		1	L
	50051	PORTACRISTAL		2	L
	50052	TAPA		2	L
	50030	PILAR		L/L1 + 1	H-40
	5070046	JUNTA VIDRIO		2	L
	5070461	ANCLAJE PAVIMENTO		N° DE PILAR	
	5079886	TAPA PORTACRISTAL DERECHA		N° BARRAS 50051	
	5079887	TAPA PORTACRISTAL IZQUIERDA		N° BARRAS 50051	
		VIDRIO SEGURIDAD (4 + 4)		N° PILASTRAS x -1	(L1 -5) x (H-H1-H2-110)
	5070382	TORNILLO,TUERCA Y ARANDELA M6 INOX		2 X (N° PILAR)	
	5070041	JUNTA RANURA PILAR		N° PILAR	H-40
		TORNILLO INOXIDABLE		N° PILAR	M8x30
	5070512	TAPA PASAMANOS IZQUIERDA		1	
	5070513	TAPA PASAMANOS DERECHA		1	